



**Spannzapfen mit Haltering**

Grösse 2



**Clamping spigot with retaining ring**

Size 2

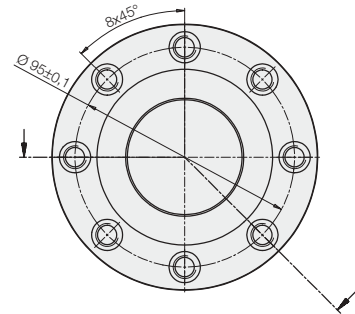

**3000 814**

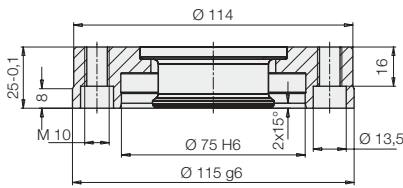

**3000 817**

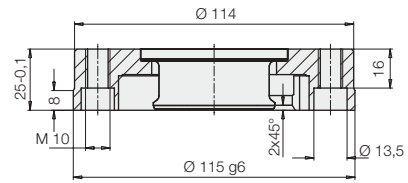

**3000 815**

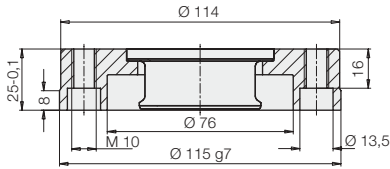

**3000 820**

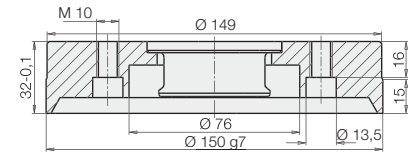

Bestell-Nr.	Bezeichnung
<b>3000 814</b>	Spannzapfen und Haltering mit Zentrierfunktion
<b>3000 815</b>	Spannzapfen und Haltering ohne Zentrierfunktion
<b>3000 817</b>	Spannzapfen und Haltering mit Ausgleichsfunktion
<b>3000 820</b>	Spannzapfen und Haltering mit Vorzentrierung

Order no.	Description
<b>3000 814</b>	Clamping spigot with retaining ring with centring function
<b>3000 815</b>	Clamping spigot with retaining ring without centring function
<b>3000 817</b>	Clamping spigot with retaining ring with compensation function
<b>3000 820</b>	Clamping spigot with retaining ring with pre-centering

**Einbaumasse Ø 115 mm  
Mounting dimensions Ø 115 mm**

Befestigung von unten  
Fixing from below

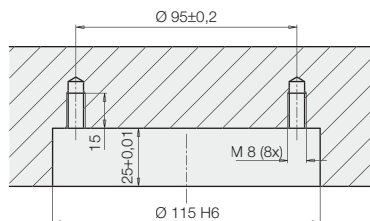

Befestigung von oben  
Fixing from above

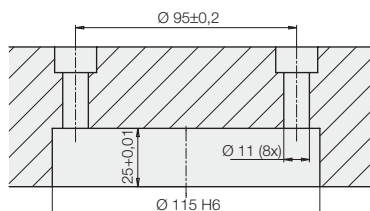

**Einbaumasse Ø 150 mm  
Mounting dimensions Ø 150 mm**

Befestigung von unten  
Fixing from below

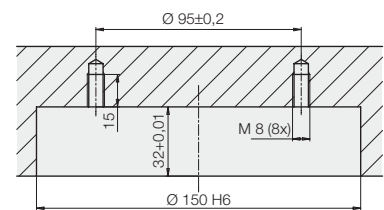

Befestigung von oben  
Fixing from above

